

# DuneStar Model 504 Bandpass Filter Characteristics

By Bob Wolbert, K6XX

The DuneStar 504 is a relay-selected bandpass filter array that allows operating two stations on different bands simultaneously—without blowing up your receiver front-ends. This model consists of five bandpass filters, one each for 160m, 80m, 40m, 20m, and 15m. The rig transmits and receives through the proper bandpass filter, which 1), reduces wideband phase noise radiated from the transmitter; and 2), prevents out-of-band power (and noise) from reaching the receiver. A band select signal from a manual switch or the radio selects the correct operating band. Coupled with the band select schemes described previously, the DuneStar filter array is completely transparent in operation. Besides its utility in protecting adjacent receiver's front ends, the filters also reduces TVI by a small amount (15dB to 20dB). Figure 1 shows the system block diagram of a dual-rig contest station employing autoswitching bandpass filters.

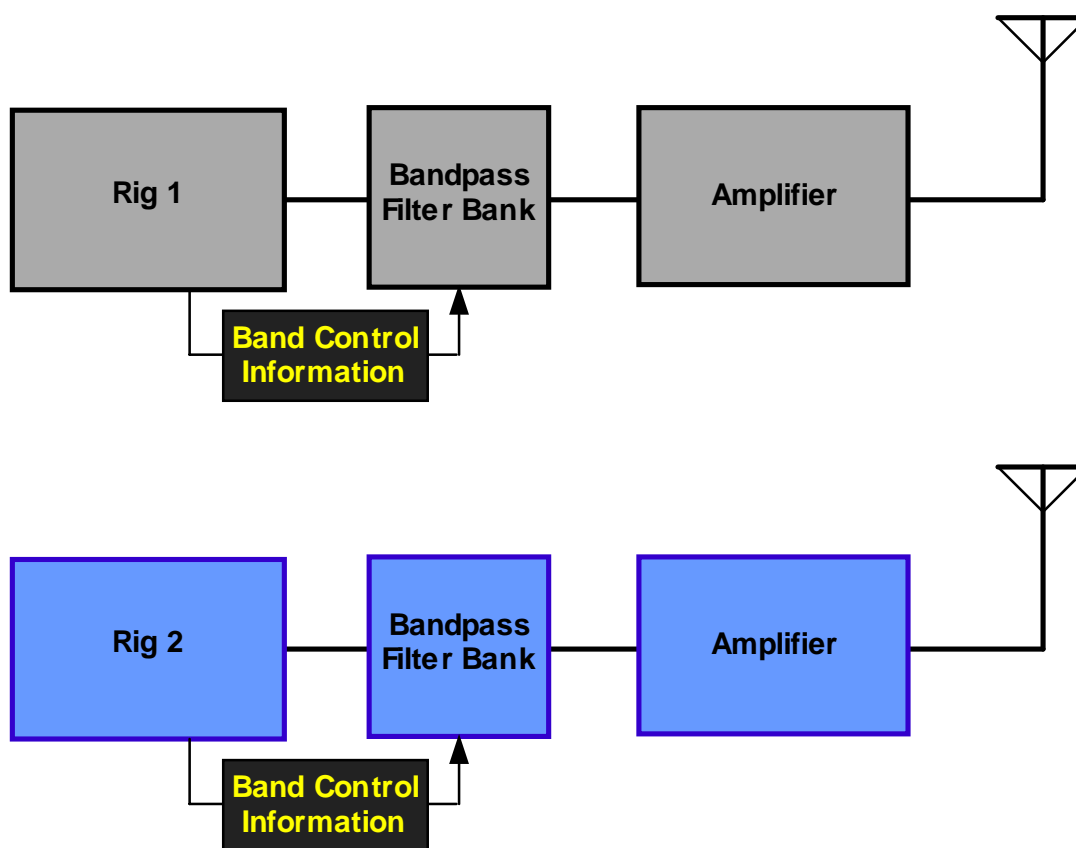

Figure 1. Block diagram of two radio contest station using automatically selected bandpass filters.

## Filter Characteristics

The DuneStar 504 was evaluated with a HP 4396B Network/Spectrum analyzer. Table 1 summarizes the band-to-band rejection characteristics of the individual filters. Oscillographs for each bandpass filter follow.

Filter	160	80	40	20	15
160	0.9	34	47	41	60
80	45	0.8	34	42	43
40	52	44	0.9	40	42
20	54	48	54	0.3	30
15	55	51	47	48	1

Table 1. Band-to Band Filter Characteristics of DuneStar 504 (Loss in dB)

## Filter Oscillographs

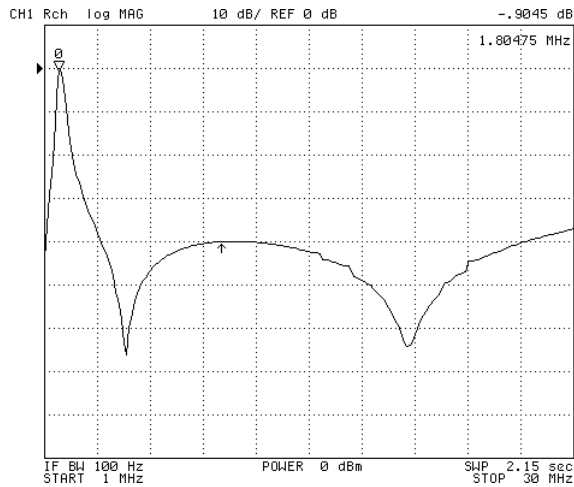

**160m Filter from 1MHz to 30MHz**

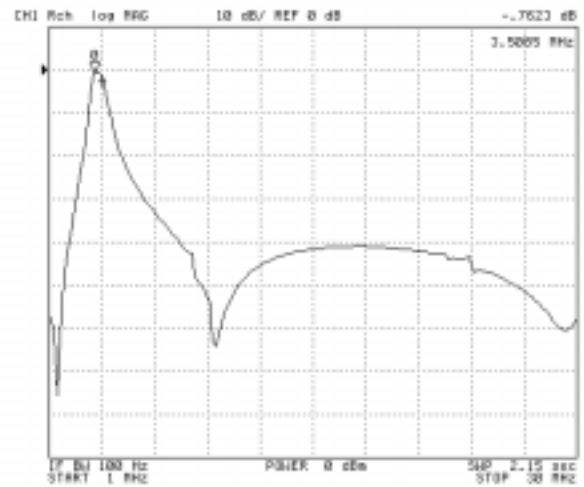

**80m Filter from 1MHz to 30MHz**

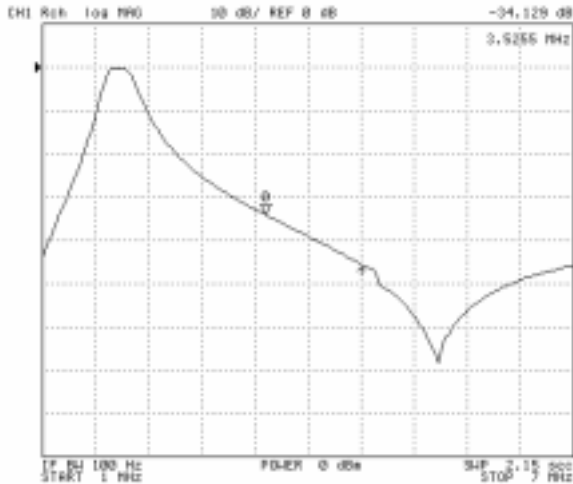

**160m Filter—Band-to-Band Characteristics**

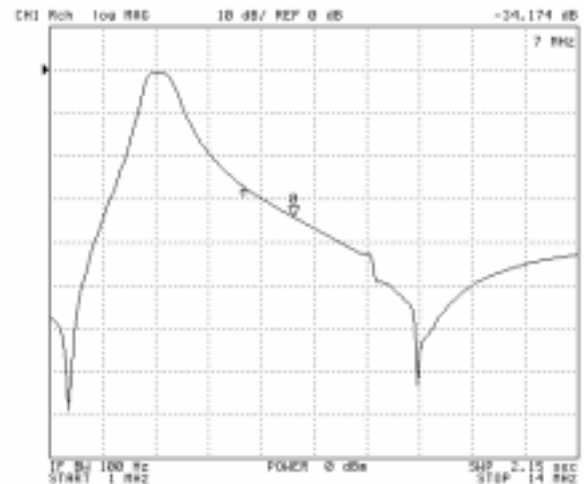

**80m Filter—Band-to-band Characteristics**

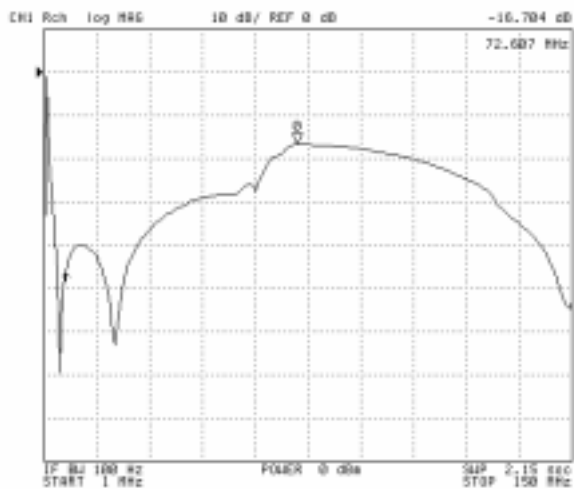

**160m Filter—Broadband Characteristics to 150MHz**



**80m Filter— Broadband Characteristics to 150MHz**

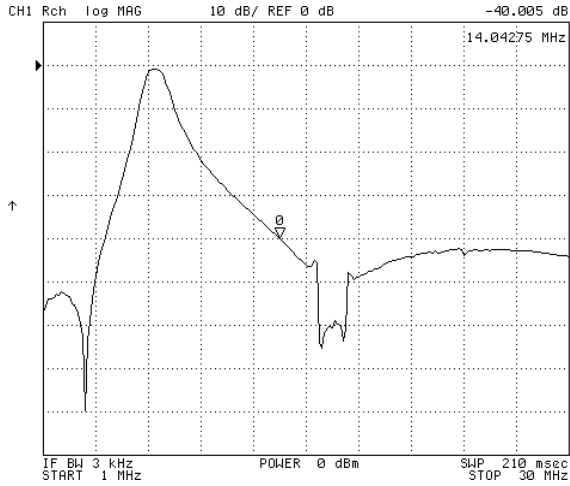

**40m Filter from 1MHz to 30MHz**

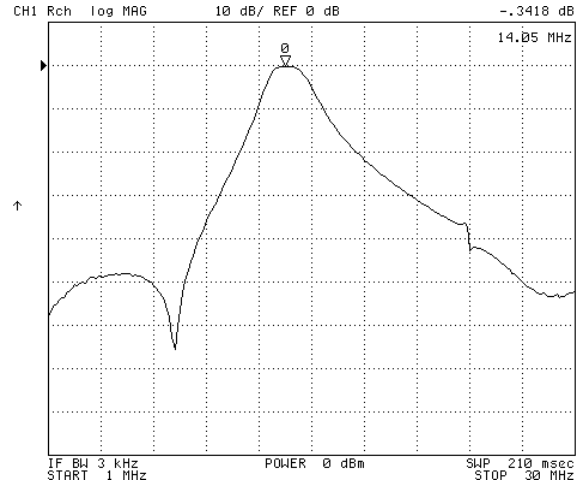

**20m Filter from 1MHz to 30MHz**

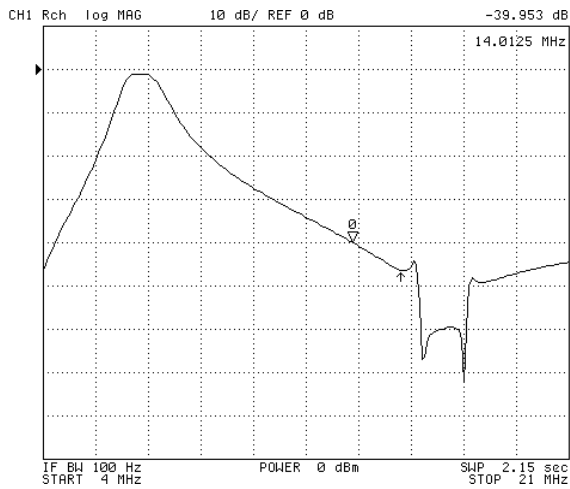

**40m Filter—Band-to-band Characteristics**

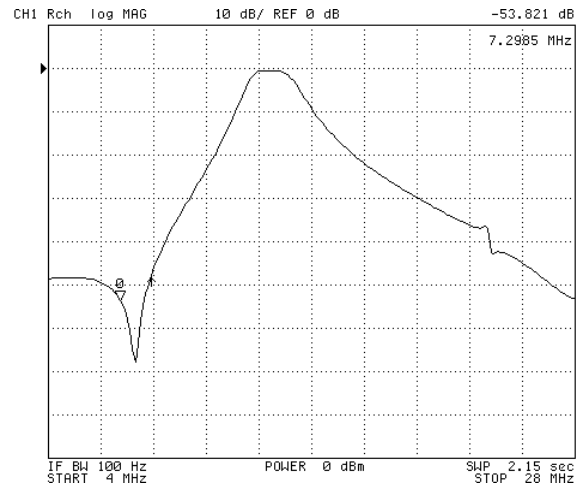

**20m Filter—Band-to-band Characteristics**

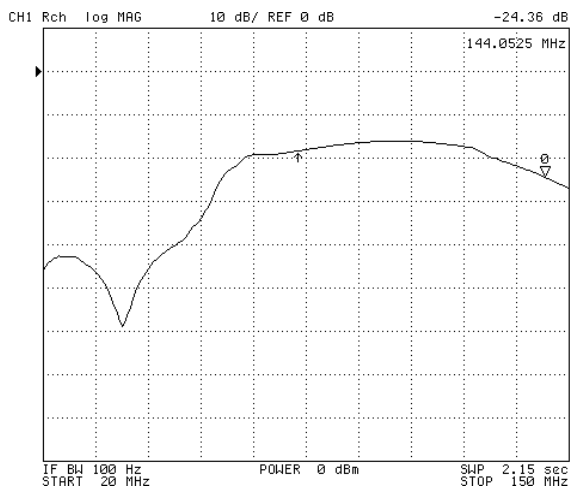

**40m Filter—High Frequency Rejection to 150MHz**

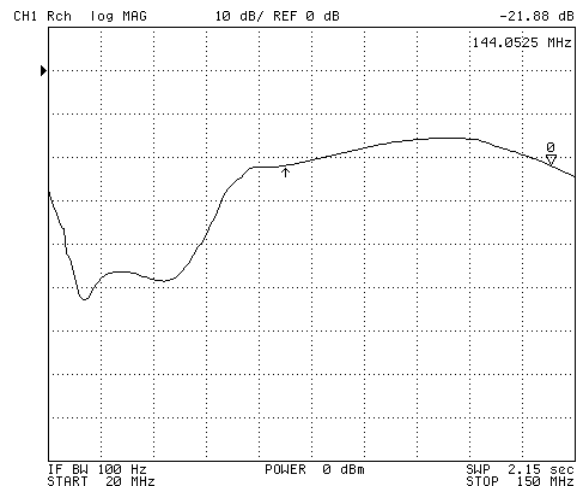

**20m Filter—High Frequency Rejection to 150MHz**

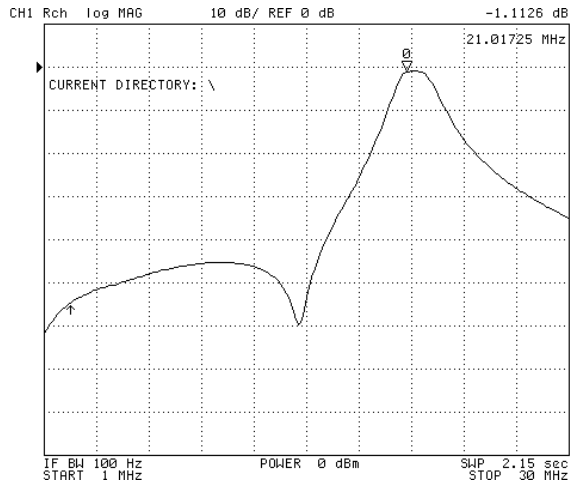

**15m Filter from 1MHz to 30MHz**



**15m Filter—Band-to-band Characteristics**

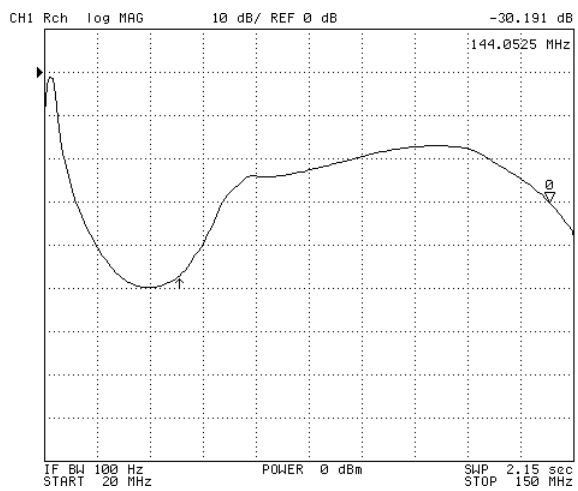

**15m Filter High Frequency Rejection to 150MHz**